



Swiss Payment Standards

Swiss Business Rules for Payments and Cash Management for
Customer-Bank Messages

SPS 2025 Version 3.2, valid from 22 November 2025

Change history

All the changes carried out in this document are listed below with the version designation, the change date, a brief description of the change and references to the chapters affected.

Version	Date	Change description	Chapter
3.2	24.02.2025	Various editorial changes Clarifications on notification for instant payments Introduction of the hybrid address More detailed description of the standardised procedure Adjustment of chapter numbering	various 2.4.4 – 2.4.6 3.1 5 6, 6
3.1	20.02.2024	Additional information on instant payments	all
3.0.2	03.01.2024	Correction of the end-date of the parallel phase Correction of various typing errors	6.1.2
3.0.1	20.12.2023	Revision of chapter "Mandatory introduction in November 2022 and November 202"	3.1.2
3.0	11.03.2022	Complete revision due to the change to the ISO 20022 version level 2019	all
2.10	26.02.2021	Last edition based on the previous ISO 20022 version level	all
1.0	15.05.2009	First edition	all

Table 1: Document history

Please address all suggestions, corrections and proposed improvements to this document to:

SIX Interbank Clearing Ltd
 Hardturmstrasse 201
 CH-8021 Zurich
 E-mail: contact.sic@six-group.com
www.six-group.com

General notes

SIX Interbank Clearing Ltd ("**SIC Ltd**") reserves the right to amend this document as required at any time and without prior notice.

SIC Ltd reserves all rights for this document including the rights of photomechanical reproduction, storage on electronic media and the translation into foreign languages.

Although great care has been taken in the compilation and preparation of this work to ensure accuracy, errors and omissions cannot be entirely ruled out. SIC Ltd cannot be held liable for any decision made or action taken in reliance on the information in this document or for any consequential, special or similar damages.

If you detect any errors in this document or have any ideas or suggestions for improvements, we would be very grateful if you would notify these by e-mail to contact.sic@six-group.com.

Table of contents

Change history	2
General notes	3
Table of contents	4
Table of tables	6
List of figures	7
1 Introduction	8
1.1 Purpose.....	8
1.2 Change control.....	8
1.3 User aspects.....	9
1.4 Delimitations.....	9
1.4.1 Range of application.....	9
1.4.2 Offerings of the financial institutions	9
1.4.3 Elements not relevant for the <i>Swiss Payment Standards</i>	9
1.4.4 Additional Optional Services (AOS).....	10
1.5 Effect on other channels	10
1.6 References.....	11
2 Business cases	12
2.1 Transfers – Credit Transfer Initiation (pain.001).....	12
2.1.1 General	12
2.1.2 Payment types	12
2.1.3 Instant payments in Switzerland and Liechtenstein	14
2.1.4 Inheritance of instructions	15
2.1.5 Grouping of payments	15
2.1.6 Forming groups.....	16
2.1.7 Grouping based on "Payment Type Information".....	16
2.1.8 Batch booking.....	17
2.1.9 Use of batch booking in Switzerland.....	17
2.1.10 Supplementary rules for instant payments.....	18
2.2 Swiss direct debits – Direct Debit Initiation (pain.008)	18
2.3 Status Report (pain.002).....	19
2.4 Customer-bank messages (reports) – Cash Management (camt.05x)	19
2.4.1 Basic message structure	19
2.4.2 "camt.053" accounting-relevant messages (day-end)	20
2.4.3 "camt.052" messages (intraday)	21
2.4.4 "camt.054" message (transaction notification).....	21
2.4.5 Notification for instant payments.....	21
2.4.6 Batch booking scenarios.....	22
3 Global topics	23
3.1 Structured and hybrid address	23
3.1.1 Structure and definition	23
3.1.2 Mandatory introduction in November 2022 and November 2026	23
3.2 References in messages.....	24
3.2.1 References in the processing chain.....	25
3.2.2 Customer references	25

3.2.3	Business case references in Cash Management messages.....	26
3.2.4	Creation of a reference	27
4	Standardised procedure.....	28
4.1	Description.....	28
4.2	Integration in the <i>Swiss Payment Standards</i>	28
4.3	Notification of incoming payments as part of the standardised procedure	28
4.3.1	Identification in the element "Entry Reference" (<NtryRef>).....	28
4.3.2	Batch booking or aggregation of incoming payments	29
4.3.3	Recommendation for incoming payments from abroad or from other networks.....	29
5	Central validation point	30
5.1	Objective.....	30
5.2	Validation portal	30
5.2.1	Scope.....	30
5.2.2	Usage	30
5.2.3	Limitations.....	30
6	Standard release cycle.....	31
6.1	Interface versions	31
6.1.1	General regulation.....	31
6.1.2	Parallel phase: November 2022 to November 2025	31
6.1.3	Information on the currently valid versions.....	31
6.2	Modifications	32
6.2.1	Entry of change requests	32
6.2.2	Consultation procedure	32
Annex A: Symbols used for graphical XML representation		33

Table of tables

Table 1:	Document history	2
Table 2:	Links to the relevant web pages	11
Table 3:	SPS payment types	14
Table 4:	Grouping variants ("single", "grouped", "mixed").....	16
Table 5:	Characteristics of the Cash Management messages.....	20
Table 6:	Accounting-relevant messages.....	20
Table 7:	Cash Management messages: "camt.052"	21
Table 8:	Cash Management messages: "camt.054"	21

List of figures

Figure 1:	Basic message structure of the "pain.001" XML message.....	12
Figure 2:	Grouping variants ("single", "grouped", "mixed")2.....	15
Figure 3:	Batch Booking FALSE.....	17
Figure 4:	Batch Booking TRUE.....	18
Figure 5:	References	25
Figure 6:	Reference creation in relation to the players	27
Figure 7:	Components of a complex element	34

1 Introduction

1.1 Purpose

The *Swiss Payment Standards* for the implementation of the message standard for "Payments Initiation" and "Cash Management" based on the ISO 20022 standard are developed on behalf of PaCoS (Payments Committee Switzerland). This version is based on "ISO 20022 Maintenance Release 2019", the current EPC recommendations and the "Cross-Border Payments and Reporting Plus (CBPR+) Guidelines" from Swift.

The *Swiss Payment Standards* consist of the following documents:

- *Swiss Business Rules* (this document)
- *Swiss Implementation Guidelines*
 - *for Credit Transfers (pain.001)*
 - *for the Swiss Direct Debit Procedure (pain.008)**
 - *for Cash Management (camt.052, camt.053 and camt.054)*
 - *for Status Report (pain.002)*
 - *for the QR-bill*

The *Business Rules* document describes the following overarching topics:

- Definition and description of the individual business cases with the relevant players and the messages used (payment types, report variants).
- Description of the most important validation rules and error handling.
- Description of global issues impacting the processing of payment instructions.
- Description of the standardised procedure with the structured remittance reference.

The respective **Implementation Guidelines** serve as a guide for the technical implementation of the standard and provide assistance for the realisation of the individual message types. They describe the XML structures and validation rules in detail. Annex A of the *Business Rules* explains the symbols used for graphical XML representation.

1.2 Change control

The *Swiss Business Rules* and *Implementation Guidelines* are subject to change by

SIX Interbank Clearing Ltd
Hardturmstrasse 201
CH-8021 Zurich

Changes and enhancements are made by SIX Interbank Clearing Ltd.

The latest version of this document can be downloaded from the SIX website at the following address:
www.iso-payments.ch.

* The *Implementation Guidelines* for the Swiss direct debit procedure (pain.008) are still based on "ISO 20022 Maintenance Release 2009".

1.3 User aspects

The *Swiss Payment Standards* are designed to enable financial institutions and their customers to make efficient payments in Switzerland and Lichtenstein.

The foundation for this is provided by the SIC and euroSIC Regulations and *Implementation Guidelines* (including instant payments), the *SEPA Credit Transfer Rulebook* and the associated *EPC Implementation Guidelines*, as well as by Swift's specific market practice for cross-border payments "*Cross-Border Payments and Reporting Plus (CBPR+)*".

The *Swiss Payment Standards* describe the minimum supporting elements and rules and ensure that an order can be executed correctly. The scope of the customer offering and the application of the regulations of the respective systems and networks may be handled differently by the individual financial institutions.

The *Swiss Payment Standards* support the end-to-end use of IBAN (International Bank Account Number) and structured data elements, especially relating to the addresses of the various parties.

The use of these elements, which is mandatory in some cases, results from the underlying regulations and specifications and is an intrinsic part of the *Swiss Payment Standards*.

1.4 Delimitations

1.4.1 Range of application

This document deals with messages for payment initiation (pain) and cash management (camt). The following messages are described:

- Customer Credit Transfer Initiation (ISO pain.001)
- Customer Direct Debit Initiation (ISO pain.008)
- Customer Payment Status Report (ISO pain.002), hereinafter referred to as the "Payment Status Report"
- Customer Account Report (ISO camt.052)
- Customer Statement (ISO camt.053)
- Customer Debit/Credit Notification (ISO camt.054)

1.4.2 Offerings of the financial institutions

The *Swiss Payment Standards* are a voluntary market practice that enable uniform order booking for the market infrastructures and schemas defined by PaCoS (Payments Committee Switzerland) and allows uniform delivery of status messages and account data.

The rules for processing customer orders (e.g. cut-off times, handling of individual attributes, handling of erroneous orders or the reporting of specific order statuses, etc.) are not described in this Market Practice, but are rather part of the customer offering and may be handled differently in the individual institutions.

1.4.3 Elements not relevant for the *Swiss Payment Standards*

Financial institutions are free to accept and process elements that are not described in the *Business Rules* and *Implementation Guidelines* of the *Swiss Payment Standards*. It is the responsibility of the respective financial institution to document these enhancements and to inform the end customer of the corresponding processing rules.

In the case of cash management messages (delivery of account data to end customers), only the elements that are relevant for payment transactions in Switzerland are described. Financial institutions may also supply additional elements provided for in the messages which are not described in the *Swiss Payment Standards*.

1.4.4 Additional Optional Services (AOS)

AOS The recommendations in this document are supported by all Swiss financial institutions. Additional services that are not offered by all financial institutions are identified as "Additional Optional Services" (AOS) and marked at the appropriate places.

1.5 Effect on other channels

The *Swiss Payment Standards* refer to the direct exchange of ISO 20022 messages. The description of the respective elements and their validation can also be applied analogously to the other channels in the customer-bank relationship. This facilitates interoperability between the channels as well as uniform treatment of customer orders and account data provided to the customer.

In particular, the *Swiss Payment Standards* are applied directly, or mutatis mutandis, concerning the following parameters: properties of entry fields, such as length, structure or their validation; scope and structure of data provided to the customer; naming of elements in interfaces; type and use of references (see chapter 3.3).⁴

Examples include the input screens in online banking, offerings based on an API (Application Programming Interface) or other software solutions that can be used to issue a payment instruction or to receive and display account data.

The designations of the messages, the variant and the specific use in accordance with the *Swiss Payment Standards* also serve as a basis for the description of offers in technical channels or interfaces, as well as for file names.

Channel-specific features or regulatory requirements, such as for payments at post office counters, have higher priority than the *Swiss Payment Standards* and do not conflict with their application.

The rule for processing orders and providing feedback and account data is part of the customer offering and may be handled differently by the individual institutions.

1.6 References

Further information on the *Swiss Payment Standards* and the respective principles can be found on the following web pages.

Organisation	Link
SIX	www.iso-payments.ch validation.iso-payments.ch www.einfach-zahlen.ch www.paymentstandards.ch
SIC Ltd (SIX Interbank Clearing Ltd)	www.six-group.com/interbank-clearing
EPC	www.europeanpaymentscouncil.eu
Swift	www.swift.com
ISO 20022	www.iso20022.org
The Wolfsberg Group	www.wolfsberg-principles.com

Table 2: Links to the relevant web pages

2 Business cases

The *Swiss Payment Standards* support the most common business cases in payment transactions for the customer-bank interface.

The following explanations describe the regulations that are applied uniformly within the framework of the *Swiss Payment Standards* in addition to the individual *Implementation Guidelines*.

2.1 Transfers – Credit Transfer Initiation (pain.001)

2.1.1 General

The XML message "Customer Credit Transfer Initiation" (pain.001) is used to electronically initiate transfer orders by customers to their remitting financial institution. It is used based on the ISO 20022 XML schema "pain.001.001.09".

The "Customer Credit Transfer Initiation" (pain.001) allows order booking of multiple payment instructions for all payment types with a single message. All regulations also apply, mutatis mutandis, for the placement of single instructions.

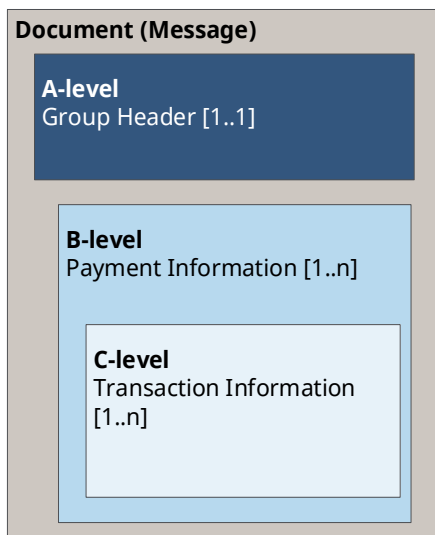

The XML message "pain.001" is essentially structured as follows:

A level: Message level, "Group Header". This block must be present exactly once.

B level: At the debtor (on the debit side), "Payment Information". This block must occur at least once and usually contains several C levels.

C level: At the creditor (on the credit side), "Credit Transfer Transaction Information". This block must occur at least once per B level. It contains all C levels (transactions) associated with the B level (debit).

Figure 1: Basic message structure of the "pain.001" XML message

2.1.2 Payment types

The *Swiss Payment Standards* distinguish between four payment types.

Payment type "D" (domestic)

Payment type "D" describes orders for payments within Switzerland and Liechtenstein that are executed in CHF and EUR via SIC or euroSIC in accordance with their regulations.

Version 1 (V1: Payments) describes general payment orders, while version 2 (V2: Instant payments) describes orders for instant payments.

Payment type "S" (SEPA)

Payment type "S" describes orders for payments executed under the *SEPA Credit Transfer (SEPA CT) Rulebook and Implementation Guidelines*.

This payment type can only be executed in EUR and requires the use of the IBAN. In addition, the charge regulation type is restricted to SLEV ("FollowingServiceLevel").

This payment type can only be used if both the debtor's and the creditor's financial institution participate in the SEPA CT procedure.

Orders that do not fulfil these conditions will be executed as payment type "X" (cross-border and foreign currency domestic).

Payment type "X" (cross-border and foreign currency domestic)

Payment type "X" describes orders for payments that are either paid to a financial institution abroad and cannot be processed using the SEPA CT procedure, or are executed within Switzerland and Liechtenstein in currencies other than CHF and EUR.

Version 1 (V1: Foreign currency domestic) describes orders for payments to financial institutions in Switzerland and Liechtenstein in currencies other than CHF or, while version 2 (V2: Cross-border) describes orders for cross-border payments.

The scope and regulations for this payment type are aligned with Swift's *Cross-Border Payments and Reporting Plus (CBPR+) Guidelines*.

This payment type can only be used if the financial institution offers it. Financial institutions may restrict the use to individual currencies or corridors.

Payment type "C" (bank cheque/PostCash)

Payment type "C" describes orders for the issue of bank cheques/PostCash, either domestic or cross-border.

This payment type can be used only in agreement with the respective financial institution.

Payment type	D	S	X	C
Title	Domestic	SEPA	Cross-border and foreign currency domestic	Bank check/ PostCash Domestic and cross-border
Comment	V1: Payment V2: Instant payment		V1: Foreign currency (FC) domestic V2: Cross-border	
Payment Method	TRF	TRF	TRF	CHK
Service level	SEPA not permitted	SEPA	SEPA not permitted	SEPA not permitted
Local instrument	V2: INST/ITP			
Creditor account	V1: IBAN (QR IBAN) or account V2: IBAN (QR IBAN)	IBAN	IBAN or account	Must not be provided
Creditor agent	Financial institution Domestic (CH/LI or with SIC connection): if the account number is used instead of the IBAN*, it is mandatory to use either: a. IID or b. BICFI	BICFI (optional)	V1: Financial institution Domestic (CH/LI): if IBAN*, then agent optional a. BICFI (CH) b. IID (optional: FI name and address) c. FI name and address V2: Financial institution cross-border a. BICFI International b. Bank code* and FI name and address c. FI name and address	Must not be provided
Currency	V1: CHF/EUR V2: CHF	EUR	V1: All except CHF/EUR V2: All	all

Table 3: SPS payment types

* Optional when using an IBAN/QR-IBAN, as the creditor agent is then determined from the IBAN/QR-IBAN

2.1.3 Instant payments in Switzerland and Liechtenstein

Instant payments – payment type "D" V2 – in Switzerland can only be made in CHF and credited to an IBAN. Financial institutions can accept orders for instant payments with "pain.001" as part of their customer offering. The *Implementation Guidelines for Customer-Bank Messages for Credit Transfer (Payment Transactions)* also describe which sub-elements of the "Remittance Information" are permitted for instant payments.

Such orders are also identified with the element "Local Instrument" with the code "INST". If an order cannot be executed as an instant payment, it is rejected and acknowledged with a corresponding Status Report (pain.002).

Financial institutions can also offer the option of executing an order rejected as an instant payment as a normal payment. It is also identified in the element "Local Instrument" with the code "ITP". The financial institution can send a respective notification with a Status Report (pain.002) and the code "ACWC".

2.1.4 Inheritance of instructions

All instructions defined on the B level are automatically valid for all corresponding C levels. For elements that are allowed on multiple levels, the definition is only allowed on one level (i.e. either the B or C level, but not both). This matches the ISO 20022 rule.

Example: Element "Category Purpose" (<CtgyPurp>): If the SALA instruction exists at the B level, then all C levels are also automatically interpreted as SALA.

2.1.5 Grouping of payments

In a message (a credit transfer initiation), payments can be grouped according to various criteria. In this case, all payments (C level) which have certain common features, e.g. the same execution date (Requested Execution Date), are grouped together in a single Payment Information (B level).

In principle, there are three possible variants as to how individual payments can be grouped at the B level. In addition to the specifications from the ISO standard, provisions from these *Business Rules* and the *Implementation Guidelines* influence the structuring of the B and C levels. These are described below.

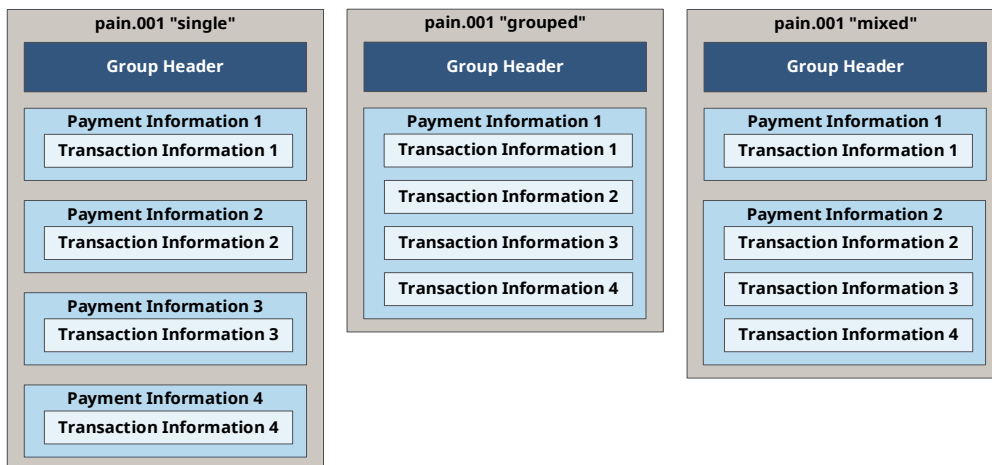

Figure 2: Grouping variants ("single", "grouped", "mixed")²

Variants	Description
single	Each B level contains exactly one C level. In this variant, the B level elements are repeated for each C level, even if they are identical. This structure usually causes all payments to be executed and booked individually.
grouped	The message contains only one B level. All elements that can be delivered at the B level are used only once per message. However, this requires that the data values in the elements "Payment Type Information", "Ultimate Debtor" and "Charge Bearer" are identical for all payments.
mixed	Several B levels with one or more C levels are used. This structure allows the batch booking of the individual C levels per B level (one posting per B level). This is the most frequently used structure.

Table 4: Grouping variants ("single", "grouped", "mixed")

2.1.6 Forming groups

Payments for which all elements of the B level are identical can be grouped together into a B level (see the *Implementation Guidelines* for elements in the B level).

The following elements can be used either on the B or C level but not on the B and C level at the same time. If these elements (including their sub-elements) are identical, they can be supplied at the B level.

- "Payment type information" (for details, see section 2.1.7)
- "Ultimate Debtor"
- "Charge Bearer"

2.1.7 Grouping based on "Payment Type Information"

The "Instruction Priority" and "Category Purpose" sub-elements are only considered when used at the B level. Their use therefore always results in a separate B level. If both elements are identical in two C levels, they can be combined into a B level if the C levels allow this.

- "Payment Type Information" / "Instruction Priority"
- "Payment Type Information" / "Category Purpose"

As a consequence, the following sub-elements must also be identical since they must also be supplied with the "Payment Type Information" component at the B level.

- "Payment Type Information" / "Service Level"
- "Payment Type Information" / "Local Instrument"

Rule: For all payments (C level) in which "Instruction Priority" or "Category Purpose" are to be used, a separate B level must be constructed for each unique combination of "Instruction Priority", "Category Purpose", "Service Level" and "Local Instrument".

2.1.8 Batch booking

The element "Batch booking" <BtchBookg> controls whether a batch or individual booking is to be made by the financial institution:

- TRUE: A batch booking is made per Payment Information (B). Across each B level, the currency as well as the elements "Charge Bearer" and "Instruction Priority" must be identical.
- FALSE: An individual booking is to be made per Credit Transfer Transaction Information (C).

If the element is not supplied, the booking will be made in the same way as TRUE.

2.1.9 Use of batch booking in Switzerland

The Batch Booking TRUE instruction leads to a batch booking, independent of the number of transactions (C level) in a batch order (B level).

FALSE results in a single booking per Transaction Information (C):

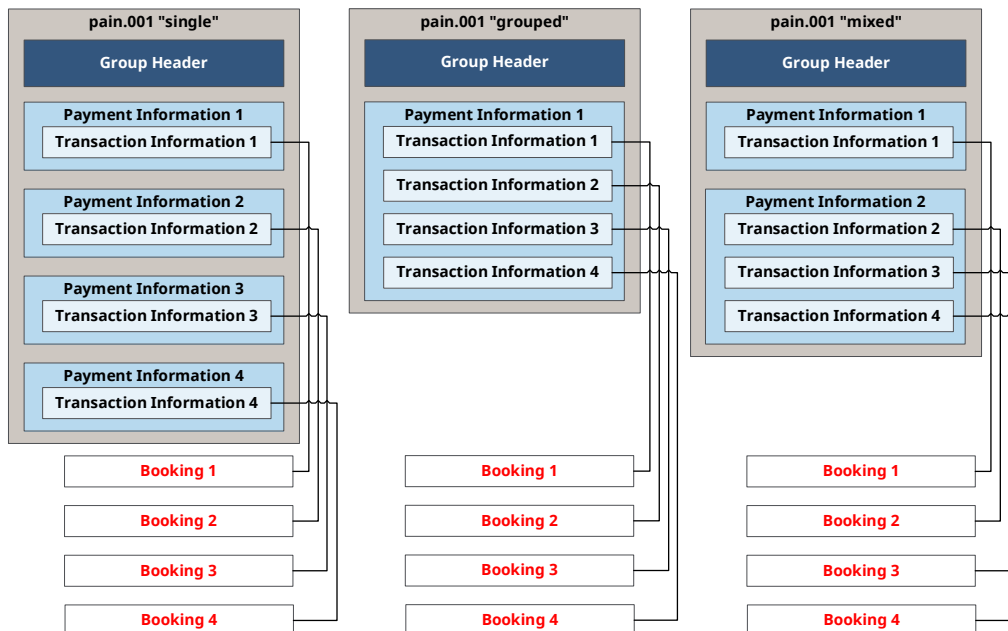

Figure 3: Batch Booking FALSE

TRUE results in a batch booking per B level, if possible (prerequisite: currency, charge bearer, etc. are the same):

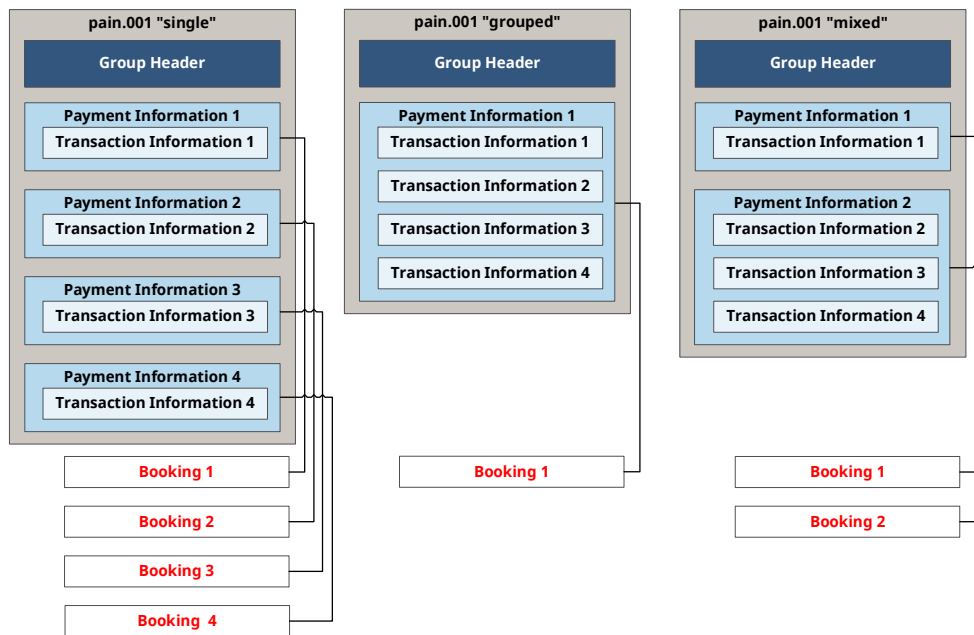

Figure 4: Batch Booking TRUE

The messages are consequently validated or rejected in case of error.

Note: The indication in the element "Batch Booking" is not an "Order" but a request from the customer to the financial institution, which the financial institution will comply with as far as possible. Implicitly, the application of this element also has an impact on further notifications, e.g. account statements in paper or electronic form.

2.1.10 Supplementary rules for instant payments

- If offered by the financial institution, orders for instant payments can also be transmitted with "pain.001". Instant payments are marked with corresponding codes in the element "Local Instrument" (see chapter 2.1.3).
- **When grouped in a B-level, all payments (C-level) must have the same code. In addition, instant payments may not be combined with payments (without "Local Instrument"). The other grouping rules remain in place.**
- Financial institutions may require instant payments to be delivered in a separate "pain.001" and not combined with other payments.
- Financial institutions may restrict the use of "Batch Booking TRUE" and exclude it for instant payments.

2.2 Swiss direct debits – Direct Debit Initiation (pain.008)

The A, B and C levels for direct debits are interpreted in the same way as in a "Customer Credit Transfer", although the "Debtor" and "Creditor" roles are reversed (the B level corresponds to the "Creditor" and the C level corresponds to the "Debtor"). The definitions of the elements in chapter 2.1 "Transfers – Credit Transfer Initiation (pain.001)" also apply correspondingly to direct debits.

The specific details for processing the "Customer Direct Debit Initiation" (pain.008) message are described in the *Implementation Guidelines* for the Swiss Direct Debit Procedure.

ISO 20022 Maintenance Release 2009 (pain.008.001.02 and pain.002.001.03) is supported. There are currently no plans to switch to a newer version.

Analogous to the payment instruction, the financial institutions generally provide a Status Report in the "pain.002" format for each submitted message, although a "pain.002.001.10" (2019 version) can also be used for this purpose.

SIX has decided, in consultation with the committees of the Swiss financial centre, to discontinue the existing direct debit procedures LSV*/BDD on 30 September 2028. For this reason, the corresponding *Implementation Guidelines* will not be updated.

2.3 Status Report (pain.002)

A submitted "Customer Transfer Initiation" or "Customer Direct Debit Initiation" is always answered with at least one "Payment Status Report".

The status message is a direct, instantaneous response by the financial institution to the received "Customer Credit Transfer Initiation" or "Customer Direct Debit Initiation" message. The status message can either be a response to the entire message or only to individual B levels of the message. It is not an execution confirmation from the financial institution, so the status message cannot be used to reconcile debits or incoming payments.

For Instant payments, an additional "Customer Payment Status Report" (pain.002) can now be provided for each transaction, confirming the execution with ACSC (Accepted, Settlement Completed, Debit to Debtor Account) or informing about the rejection with RJCT.

The detailed description of the "Customer Payment Status Report" (pain.002) is provided in its corresponding *Implementation Guideline*. This *Guideline* also contains several Additional Optional Services (AOS) for the Status Report.

2.4 Customer-bank messages (reports) – Cash Management (camt.05x)

The Cash Management messages are used for reporting purposes for customers acting as the debtor (<Debtor>) or as the creditor (<Creditor>).

Swiss financial institutions can provide the following message types within the framework of the *Swiss Payment Standards*.

2.4.1 Basic message structure

In messages (A level, Document), the B, C and D level blocks are interpreted in customer cash management as follows:

- B level: Account level (Statement) – information in the statement (report) that relates to the account, e.g. account number, currency and balance.
- C level: Amount level (Entry) – information about an entry, e.g. date, debit/credit, amount and currency. The C level is repeatable and may be missing if there are no entries.
- D level: Amount details (Entry Details) – detailed information about a booking, e.g. debtor references (e.g. "End to End Identification" or creditor reference ("Remittance Information", e.g. QR-Reference or Creditor Reference) previously entered in the "pain.001".

The following overview shows the most important differences in the significant information.

Information/message	camt.052 Account Report	camt.053 Statement	camt.054 Debit/Credit Notification
Header (A level)	Mandatory	Mandatory	Mandatory
Account (Statement: B level)	Mandatory [†]	Mandatory	Mandatory [‡]
Booking (Entry: C level)	Optional	Optional	Mandatory
Details of the booking (Entry Details: D level)	Optional	Optional	Mandatory
Booking	✓	✓	✓
Reservation	✓	-	✓
Booking details	✓	✓	✓

✓ = attribute may occur / - = attribute does not occur

Table 5: Characteristics of the Cash Management messages

Definitions:

Booking: This is a definitive transaction that cannot be adjusted or deleted. A correction can only be made via a cancellation entry that is visible to the customer. Even if a booking is the result of intraday processing, a correction is only possible via a reversal entry.

Reservation: The reservation becomes a booking at day-end (see above) or is deleted. In addition, the conversion into a booking may result in adjustments to the effective amount.

The effective handling and differentiation or the time of conversion of reservations and bookings may differ per financial institution.

2.4.2 "camt.053" accounting-relevant messages (day-end)

The XML message "Bank-to-Customer Statement" (camt.053) is used by financial institutions to send account information to their customers. Essentially, the following accounting-relevant messages are available according to the *Swiss Payment Standards*:

New ISO 20022 messages	Examples of alternative messages
1. camt.053 account statement with internal batch booking breakdown	MT940 Customer Statement Message
2. camt.053 account statement with external batch booking breakdown in a camt.054 [§]	

Table 6: Accounting-relevant messages

[†] balance optional

[‡] without balance

[§] Not every financial institution offers the message "camt.053" for the account statement with external batch booking breakdown in a "camt.054".

2.4.3 "camt.052" messages (intraday)

The delivery of the ISO 20022 message "camt.052" for the Intraday Account Report** (account turnovers, reservations) is possible periodically (e.g. hourly) or daily at fixed times.

There are two variants of intraday messages. The first variant contains all transactions since the last regular account statement (camt.053), the second variant contains only the transactions since the last intraday statement.

According to *Swiss Payment Standards*, the following "camt.052" intraday cash management messages are available:

New ISO 20022 messages	Examples of alternative messages
1. camt.052 account report with internal batch booking breakdown	MT941 Balance Report MT942 Interim Transaction Report
2. camt.052 account report with external batch booking breakdown in a camt.054	

Table 7: Cash Management messages: "camt.052"

2.4.4 "camt.054" message (transaction notification)

The "camt.054" message is used to notify credits and debits. This can concern both individual transactions and the details of a batch booking (detailed notification).

A single "camt.054" message can contain one or more bookings (individual and batch bookings) as a detailed notification.

The breakdown of batch bookings via "camt.054" detailed notification can be offered independently and in addition to the use of "camt.054" for debit and credit notifications.

New ISO 20022 messages	Examples of alternative messages
1. camt.054 notification (debit and credit advices)	MT900 Confirmation of Debit MT910 Confirmation of Credit Proprietary reports (detailed notifications)

Table 8: Cash Management messages: "camt.054"

2.4.5 Notification for instant payments

The "camt.054" can be used to immediately notify the debit and credit of an instant payment and can be used for automatic reconciliation of accounts payable with a structured reference.

The «camt.054» can be offered with the following variants and in combinations thereof:

- Immediate individual notification (regardless of whether the incoming payment is credited as an individual booking or part of batch booking/aggregation).
- Periodic detailed notification as an individual credit or part of a batch credit.

When collecting/aggregating incoming payments in the standardised procedure in accordance with chapter 4, the financial institutions may provide for a combined offer for incoming instant payments as part of their customer offering. This can include immediate notification (e.g. with a

** Not every financial institution offers messages relevant for cash management.

"camt.054" credit advice) with simultaneous batch booking/aggregation of incoming payments with periodic booking and the corresponding cancellation in a "camt.053" or in a separate "camt.054".

Regardless of the type of notification, an "Account Servicer Reference" must be provided at the Transaction Details level (D-Level). In the case of multiple notifications (combined offer), a duplicate check can be carried out using the "Account Servicer Reference".

2.4.6 Batch booking scenarios

The *Swiss Payment Standards* support different batch booking scenarios.

- **Customer collects:** The customer instructs the collection of direct debits or credits using the batch booking indicator in the credit transfer messages (pain.001) or the orders for SEPA direct debits (pain.008).
- **Financial institution collects:** Direct debits or credits are collected based on the settings in the customer's master data or as part of a specific customer offering, for example when QR-bills are received or are from the Swiss direct debit procedure.

The rules for batch booking and breakdown within a standardised procedure are described in chapter 4.

3 Global topics

The topics covered in this chapter relate to developments and offers that have a direct or indirect impact on all *Implementation Guidelines* of the SPS.

3.1 Structured and hybrid address

3.1.1 Structure and definition

In the ISO 20022 data model, the address is defined as the "PostalAddress" component used in payment messages. It consists of various sub-elements that are either specifically defined, e.g. "Floor – Max70Text – [0..1] – Floor or storey within a building", or described in an open manner, e.g. "AddressLine – Max70Text – [0..7] – Information that locates and identifies a specific address, as defined by postal services, presented in free format text". The terms "unstructured", "structured" or "hybrid" address do not originate from ISO 20022, but describe which elements are used to describe the address in a specific implementation.

The following sub-elements are recommended for the structured address of parties in Switzerland and Liechtenstein: "Street Name", "Building Number", "Post Code", "Town Name" and "Country".

The use of additional elements for foreign addresses is based on the recommendations of the respective country or market area.

The "hybrid" address consists of a selection of defined elements – like the "structured" address, supplemented with a maximum of two sub-elements <AdrLine>, whereby one piece of information about the address may not occur more than once (e.g. the street name may be provided either in the sub-element <StrtNm> or in the sub-element <AdrLine>, but not in both).

The specification of the places "Town Name" and "Country" are mandatory in any case and are obligatory elements in the message.

The implementation is described in the *Swiss Implementation Guidelines for Customer-to-Bank Messages for Credit Transfers in Payment Transactions* chapter 3.11 "Use of address information".

3.1.2 Mandatory introduction in November 2022 and November 2026

Since November 2022, the structured address must be used for the parties "Ultimate Creditor" and "Ultimate Debtor" in cross-border payment transactions (payment type "X").

Following various market feedback, the originally planned launch has been postponed to November 2026.

From November 2025, the option "hybrid address" will also be introduced for Switzerland and Liechtenstein (SIC/euroSIC), the SEPA schemes (SCT, SCT Inst, SDD Core, SDD Business) and Swift (CBPR+). It supplements the structured address with the option of providing information in two general elements "Address Line". The obligation to provide the place and country also applies when using the "hybrid address".

The specific implementation is described in the *Implementation Guidelines for Credit Transfers* (version 2.2).

However, due to the already high usage of the structured address in Switzerland and in Liechtenstein, the *Swiss Payment Standards* will not be generally adapted. Nonetheless, a tolerance rule has been introduced to facilitate implementation.

Until further notice, the specification of the house number (element "Building Number") in the element "Street Name" is permitted and will not be rejected when placing an order. For SEPA and cross-border

payments in particular, the transaction may still be rejected depending on the regulations and handling in the recipient country. A similar tolerance exists for the QR-bill, which is described in the *Swiss Payment Standards: Swiss Implementation Guidelines for the QR-bill*, version 2.3 dated 20 November 2023.

The use of the structured address will be mandatory for all parties and all payment types ("D" for domestic, "S" for SEPA, "X" for cross-border and domestic foreign currency) starting from November 2026. The financial institutions can also enable their customers to use the "hybrid address" as part of their offering.

Furthermore, depending on the payment type, it remains also possible to replace the address with another element like the BIC. The details are described in the *Implementation Guidelines*.

The minimum requirements are based on the specifications in the respective interbank payment traffic, such as the *Implementation Guidelines* for Interbank Messages in SIC/euroSIC, the requirements of the EPC and the rules for cross-border payment traffic, as well as the underlying regulatory provisions. For deposits at the post office counter, there are additional requirements for the "Ultimate Debtor" data.

If the minimum requirements are not met, financial institutions may reject a payment instruction.

Payment orders with an unstructured address in accordance with the *Implementation Guidelines for Credit Transfers* (version 2.1.1) can only be processed until the SIC release of 20 November 2026. In order to ensure timely processing, financial institutions can refuse to accept payment orders with unstructured addresses before this deadline.

Domestic LSV⁺/BDD procedures and the issuing and processing of bank cheques are exempt from the obligation to provide a structured address. Individual financial institutions are free to continue to accept the unstructured address for other payment types as part of their customer offering.

3.2 References in messages

The references used in the various ISO 20022 messages serve to identify a message, a transaction or a specific business case.

In addition to point-to-point references that are only used between the individual players of a message, there are also end-to-end references that are transmitted unchanged along the entire transmission path from the debtor to the creditor. Furthermore, there can be references from other systems, such as a booking reference or a business case reference outside of payment transactions in the case of cash management messages.

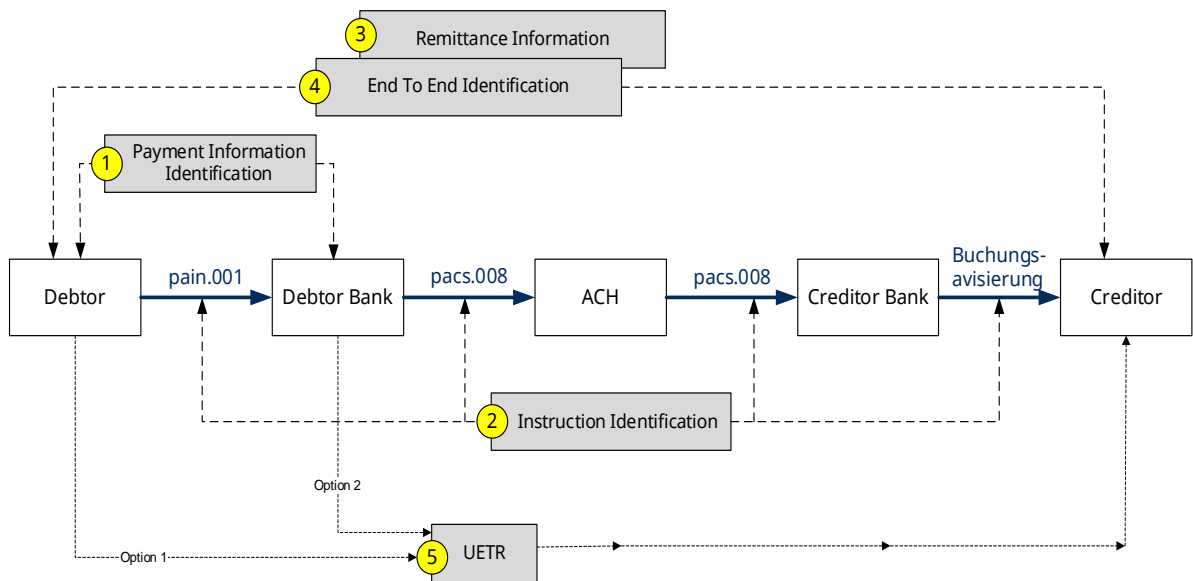

Figure 5: References

3.2.1 References in the processing chain

This type of reference is used to identify a message, a message part (e.g. Payment Information Identification ¹) for a payment group) or a transaction (Instruction Identification ²) and is always reassigned in the processing chain.

These references have no meaning for the actual business case, but are used for technical assignment, among other things.

3.2.2 Customer references

A customer reference is usually passed on unchanged throughout the entire processing chain. This enables a clear assignment of the transaction or the underlying business case.

The following customer references are provided for payment instructions in the *Swiss Payment Standards*.

3.2.2.1 Customer reference as "Remittance Information" ³

The references in the "Remittance Information" are created by the creditor and communicated to the debtor as part of the invoicing or instruction to settle a claim.

The debtor provides this reference when creating a payment instruction. Provided that the respective systems in processing support this, the reference is passed on unchanged along the entire processing chain and made available to the creditor. In the direct debit procedure, the reference is provided by the beneficiary with the direct debit instruction and forwarded by the debtor's financial institution in the payment.

The "Remittance Information" can be provided in structured form (the creation of the reference is predefined and can be validated) or unstructured form (free text). The structured reference is used in Switzerland and Liechtenstein for standardised procedures according to chapter 4.

This enables the creditor to allocate the incoming payment to the respective business case and to update their accounts receivable. When using structured references, this process can be easily automated.

The Swiss Payment Standards describe the following references for "Remittance Information":

- Use of the Swiss QR reference

In Switzerland, the QR reference allows creditors to automatically match their invoices with incoming payments. The QR reference corresponds to the former ISR reference: 26 numeric characters (to be freely assigned by the customer) plus a check digit. Use of the QR reference is only permitted and is required in connection with a QR-IBAN in the element "Creditor Account/IBAN".

This reference is formally checked throughout the entire processing chain and rejected in the event of an error.

- Use of the ISO Creditor Reference

The ISO Creditor Reference (ISO 11649) allows creditors to automatically match their invoices with incoming payments.

Changing this reference is not allowed. It must contain the "RF" value in positions 1-2 and a correct check digit in positions 3-4. It can contain a maximum of 25 characters.

Note: For payment type "D" (domestic, payment in CHF and EUR), the ISO creditor reference according to ISO 11649 must be supplied when using the "SCOR" reference type code.

- Use of the IPI reference

The IPI (International Payment Instruction) reference is another structured reference type supported in SPS, which can be used analogously to the ISO creditor reference. Today, it is only used in the direct debit procedure.

- Unstructured customer reference

Instead of the structured reference, a customer reference can also be provided in unstructured form, maximum length: 140 characters).

3.2.2.2 "End To End Identification" ⁴

"End To End Identification" is used to uniquely identify a transaction and is assigned by the debtor. This reference enables both the automatic allocation of a debit in the debtor's accounting and the identification of a transaction in the event of clarifications or queries, e.g. in contact with the creditor or the financial institutions involved.

3.2.2.3 "UETR" ⁵

The "UETR" (Unique End-to-End Transaction Reference) is a globally unique reference comprising a Universally Unique Identifier (UUID). The reference formed in this way is always globally unique and one-of-a-kind and enables tracking across multiple parties or systems, for example. However, it does not contain any further business logic and can therefore only be used for transaction reconciliation to a limited extent.

3.2.3 Business case references in Cash Management messages

In Cash Management messages, in addition to references from incoming and outgoing payments, references are also provided from other financial institution systems or other business cases underlying a creditor booking.

Examples include the actual booking reference ("Account Servicer Reference") or references from card transactions.

3.2.4 Creation of a reference

Depending on their type and use, references are created by all players in the processing chain or originate from outside and are supplied for a specific transaction.

If a reference is mandatory due to the schema used (XSD), but is not available for processing reasons, it is replaced by "NOTPROVIDED" if allowed.

The following graphic shows an example of which player creates a specific reference.

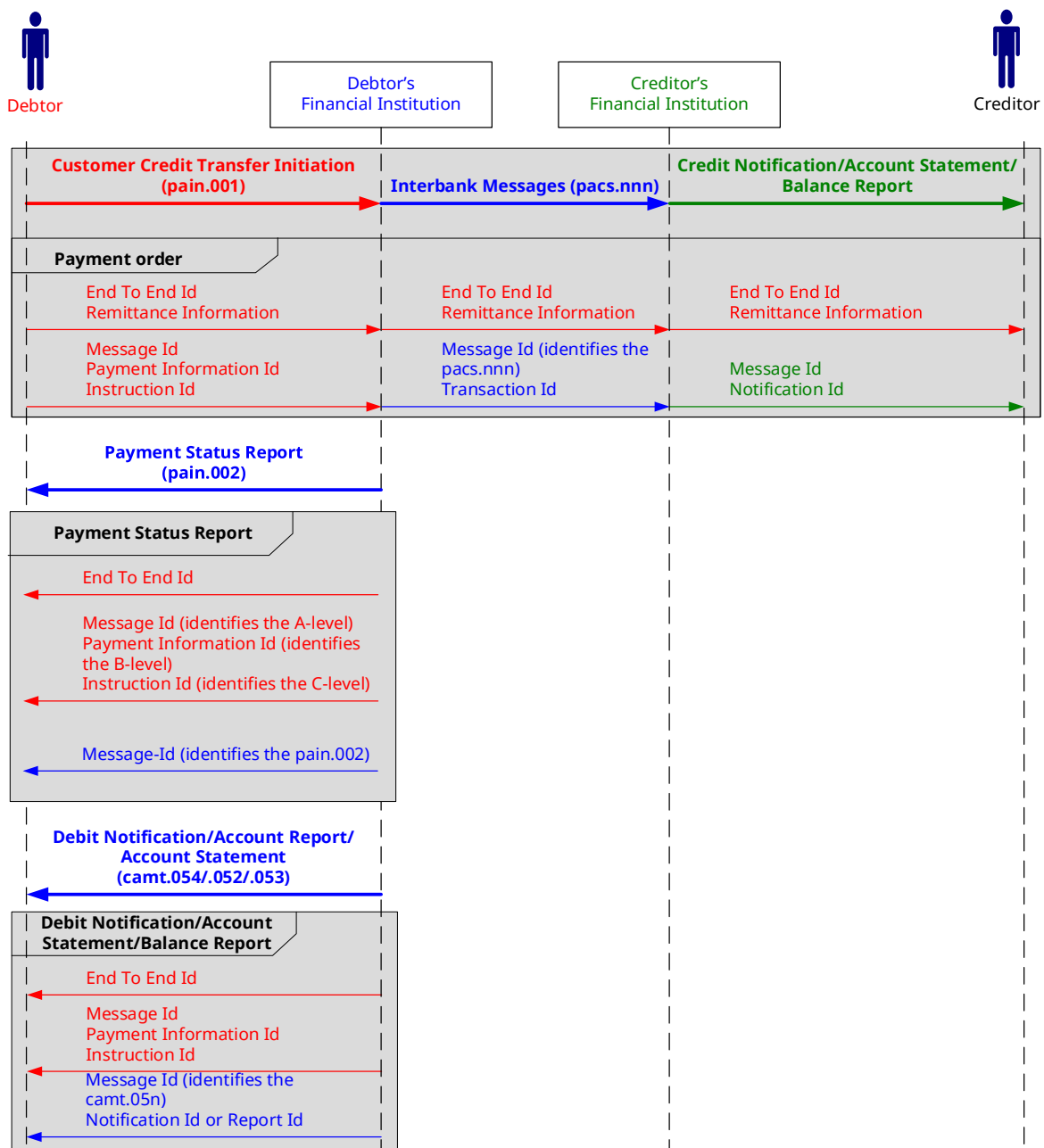

Legend:

Elements marked in red are generated by the debtor.

Elements marked in blue are generated by the payer's financial institution.

Elements marked in green are generated by the payee's financial institution.

Figure 6: Reference creation in relation to the players

4 Standardised procedure

4.1 Description

The standardised procedures in Switzerland allow an invoice issuer or service provider to easily and efficiently allocate incoming payments.

The procedures are based on a structured and standardised reference that can be formally validated both when instructions are placed and when payments are processed. Orders with a formally invalid or missing reference are generally rejected.

Checking and securing the reference allows automated reconciliation with the respective claims when payments are received.

In Switzerland and Liechtenstein, the term "standardised procedure" includes QR-bill with QR-IBAN and QR reference, QR-bill with IBAN and SCOR reference, DD⁺/BDD and the PostFinance CH-DD direct debit procedure.

The regulations for the standardised procedure are also applied, mutatis mutandis, to SEPA payments with a SCOR reference, although no validation is carried out here when the instruction is placed or the payment is processed.

4.2 Integration in the *Swiss Payment Standards*

The specifications for the validation of payment orders or direct debit instructions are described in the relevant *Implementation Guidelines* for "Customer Credit Transfer Initiation (ISO pain.001)" and "Customer Direct Debit Initiation (ISO pain.008)". For the creation of a QR-bill, the *Swiss Implementation Guidelines* for QR-bills must also be observed.

Incoming payments are credited in accordance with the *Swiss Implementation Guidelines* for Customer-to-Bank Messages (Reports), Bank-to-Customer Account Report (camt.052), Bank-to-Customer Statement (camt.053) and Bank-to-Customer Debit/Credit Notification (camt.054).

4.3 Notification of incoming payments as part of the standardised procedure

4.3.1 Identification in the element "Entry Reference" (<NtryRef>)

In addition to the specifications on message content, the standardised procedure includes a specific regulation regarding the notification of incoming payments. In the camt.05x messages, an identification is always provided for each credit in the element "Entry Reference" (<NtryRef>).

The information about individual incoming payments is provided to the customer with a batch booking breakdown in a "camt.053" or with a separate "camt.054".

The identification ("Entry Reference", <NtryRef>) has the following variants, which are also used for the batch booking logic (see 4.3.2):

QR-bill (including orders from eBill with (QR-)IBAN and QR/ISO reference)

Variant 1: QR-IBAN in the format CH4431999123000889012

Variant 2: QR-IBAN and first 6 digits of QR reference (example: CH4431999123000889012/123456)

Variant 3: IBAN in the format CH4412345123000889012

Variant 4: IBAN and digits 5–10 of the ISO Creditor Reference

Variant 3 and 4 can be applied analogously to incoming SEPA payments.

The upper/lower case is not relevant for the collection (example: CH4412345123000889012/123ABC).

DD⁺/BDD

Variant 5: ISR participation number in DD in the format 010001628

Variant 6: ISR participation number in DD and ISR bank ID (example: 010001628/123456)

CH-DD direct debit

Variant 7: Invoice issuer PID in the format 4110000000872800

eBill Direct Debit

The distinction between incoming payments from QR-bill/eBill can be seen in the different BTC. Otherwise, the variants of the QR-bill apply accordingly.

4.3.2 Batch booking or aggregation of incoming payments

If batch booking or aggregation of incoming payments is provided as part of the offer, this results in a single credit per identification ("Entry Reference") to the respective account for one to several incoming payments in a certain period or after a certain number of incoming payments.

The identification used (e.g. BESR-ID, RS-PID) or (QR-)IBAN is the first criterion for batch booking. As an additional service, a batch booking can be made based on a specific part of the reference. For eBill Direct Debit, the respective BTC is also used as an additional batch booking logic and differentiation.

The information about individual incoming payments is provided to the customer with a batch booking breakdown in a "camt.053" or with a separate "camt.054".

When batch booking incoming instant payments, the financial institutions may provide for a combined offer for incoming instant payments as part of their customer offering in accordance with Chapter 2.4.5.

4.3.3 Recommendation for incoming payments from abroad or from other networks

When making a cross-border payment via Swift or SEPA, it is possible to pay with a QR-IBAN. In this case, it is not ensured that a structured QR reference is available, or that it is complete and correct. The decision to credit or reject such an incoming payment rest with the creditor's financial institution.

The following procedure is recommended for crediting incoming payments to a QR-IBAN without a valid QR reference:

- The credit is made as an individual credit directly to the bank account linked to the QR-IBAN without specifying the QR-IBAN in the element "Entry Reference".
- The credit is issued as an entry without a structured reference.
- These incoming payments are therefore neither collected nor reported by means of batch booking breakdown (camt.054).
- Information from "Additional Remittance Information" is forwarded to the customer as unstructured "Remittance Information".

5 Central validation point

5.1 Objective

Implementation by customers, software providers and financial institutions is supported by a central validation portal for customer-bank messages. The goals of this portal include:

- Promoting the uniform use of the ISO 20022 standard, in particular the Swiss *Business Rules and Implementation Guidelines* by all financial institutions and software providers.
- Avoiding errors and problems in the submission and delivery of ISO 20022 messages between customers or software providers and financial institutions.

5.2 Validation portal

5.2.1 Scope

The validation portal covers the following scope:

Customers, software providers and financial institutions can upload generated "pain.001" messages (Customer Credit Transfer Initiation) to the validation portal.

The validation results are provided to customers, software providers and financial institutions in the form of "pain.002" messages and a generated description of the test result (text and HTML).

In the generated description of the validation results, a distinction is made between "errors" and "notes". Messages with "errors" are usually rejected by the financial institution. "Notes" should not result in rejection of the message, but should draw attention to possible discrepancies in the validated message.

5.2.2 Usage

Before submitting a new ISO 20022 message, or new message version, to a financial institution for the first time, the software provider/customer must contact the respective financial institution and clarify the use of the individual ISO messages. A positive result from the validation point does not replace any further-reaching institution-specific checks.

Neither real orders nor productive data (e.g. debtor, account holder, creditor) may be used for the validation portal; only artificial test data may be used.

5.2.3 Limitations

The central validation portal does not cover all possible combinations and special cases. In addition, the financial institutions may offer further options and services. For the use of such solutions, the information of the respective financial institution must be consulted and any institution-specific validation solutions must be applied.

6 Standard release cycle

6.1 Interface versions

6.1.1 General regulation

A "major" version of the *Swiss Payment Standards* is planned to be published every year in February (if required). The published definitions will be supported by all financial institutions as of November (cut-off date: date of SIC/Swift release).

The releases are always designated with the year of introduction and are valid until the next "major" version (e.g. SPS 2022: *Swiss Payment Standards* valid from November 2022).

The Swiss financial institutions guarantee the following interface compatibility:

Support of the respective "major" version of the *Business Rules* and *Implementation Guidelines* currently published by SIX Interbank Clearing Ltd.

Support of the respective previous version, subject to mandatory changes or restrictions for technical or regulatory reasons, or due to changes in the respective networks and market practices.

In addition to the annual "major" version, "minor" versions of the Guidelines may be published for corrections, clarifications and additions as required.

Note: If a customer delivers an order file in the current XML schema version, they also receive the Status Report in the same XML schema version. If the previous version is submitted, the Status Report is also returned in the previous version. A combination of XML schema versions is only possible in special cases (see chapter 2.1.10) and in consultation with the financial institutions.

6.1.2 Parallel phase: November 2022 to November 2025

SPS 2022 was associated with a change to a new ISO 2022 message version. To facilitate the transition, a three-year parallel phase is granted for the customer-bank interface until the Standards Release in November 2025.

For this parallel phase, the SPS 2021 *Implementation Guidelines* for the "pain.001", "pain.002" and cash management messages will continue to apply until November 2025. Excluded from this is the discontinued use of the previous payment slips (payment types 1, 2.1 and 2.2) as of 30 September 2022, as well as any mandatory change due to regulatory requirements.

The modifications to the *Implementation Guidelines* for SPS 2021 for the parallel phase are described in the document "*Swiss Payment Standards 2021 – Amendments for the Parallel Phase*".

6.1.3 Information on the currently valid versions

SIX publishes the versions of the *Implementation Guidelines* supported by the financial institutions in the respective SPS release at www.iso-payments.ch, under the heading "Currently valid versions".

6.2 Modifications

6.2.1 Entry of change requests

The schedule for change requests and the contact options are described at www.iso-payments.ch.

Change requests that contradict regulatory requirements or cannot be implemented with ISO 20022 cannot be considered.

The regulatory frameworks of the European Payment Council (e.g. SEPA Credit Transfer), the ISO standards and Swift have their own processes, which are published on their respective websites.

6.2.2 Consultation procedure

Prior to the publication of a new version of the *Swiss Payment Standards*, there will be a public consultation procedure on the planned changes.

The corresponding schedule as well as the respective documents will be published at www.iso-payments.ch.

Annex A: Symbols used for graphical XML representation

Expand and collapse symbols

Wherever parts of the tree structure can be expanded or collapsed, expand or collapse symbols are added to the symbols of the graphical representation. Each symbol comprises a small square containing a plus or minus sign.

- ⊕ **Expand symbol:** Clicking the plus sign expands the tree structure so that subsequent symbols (attributes or "child elements") are displayed. The expand symbol then becomes a collapse symbol.
- ⊖ **Collapse symbol:** Clicking the minus sign collapses the tree structure again, i.e. the subsequent symbols disappear. The collapse icon then becomes an expand icon again.







Elements

Elements are shown as rectangles containing the name of the element. For mandatory elements the rectangle has a solid outline. For optional elements, the rectangle has a dashed outline.

For complex elements, which unlike simple elements can contain attributes or additional elements (child elements), the rectangle has an expand or collapse symbol to the right.

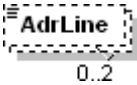
Three small dashes at the top left of the rectangle indicate that the element contains data (otherwise the element contains child elements).

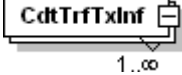
Elements that may occur more than once are shown as two rectangles, one behind the other. At the bottom right, the minimum and maximum of iterations are indicated as a range.

	Mandatory simple element
	Optional simple element
	Optional simple element that may occur a maximum of two times
	Mandatory complex element (with child elements) with collapsed tree structure
	Mandatory complex element (with child elements) with expanded tree structure
	Mandatory complex element (with child elements) that can occur any number of times
	Mandatory complex element (with attributes)

Attributes

Attributes are also represented as rectangles containing the name of the attribute. They are surrounded by a box containing the word "attributes" and an expand or collapse symbol. For mandatory attributes, the rectangle has a solid outline. For optional attributes, the rectangle has a dashed outline.

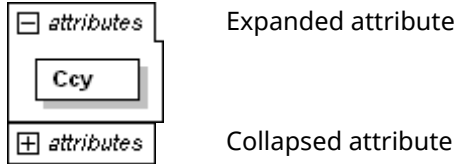

Selection

To the right of a selection symbol (choice), the connecting lines branch to the possible elements, of which only one may be present in the XML message.

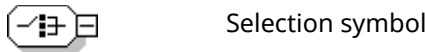

Sequence

To the right of a sequence symbol (sequence), the connecting lines branch to the elements that are to be used in the XML message in the displayed sequence (optional elements or attributes can of course also be omitted).

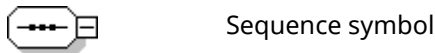

Framework

To improve clarity, all child elements, attributes and additional information belonging to a complex element are surrounded by a dashed outline with a yellow background.

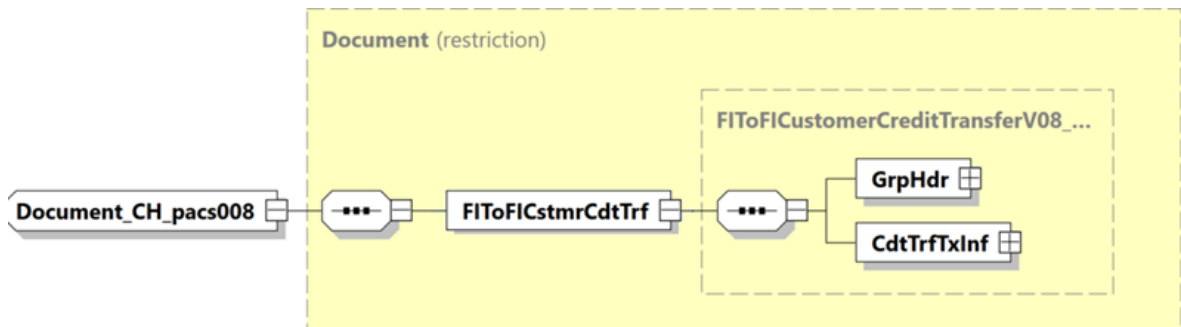

Figure 7: Components of a complex element

Elements not used in Switzerland

Elements not used in Switzerland are removed from the schema definitions and are not visible in the illustrations.